

WBO | WVS | WHO

STANDARD-WINKELVERBINDER

KOMPLETTES PRODUKTSORTIMENT

Standard-Winkelverbinder, ideal für alle kleinen Schreinerei- oder Holzbauverbindungen.

HOLZ-HOLZ

Dank der 5-mm-Löcher ideal für Holz-Holz-Verbindungen.

HOLZ-BETON ODER MAUERWERK

Die größeren Bohrungen bei einigen Modellen ermöglichen die Befestigung an Beton und Mauerwerk.

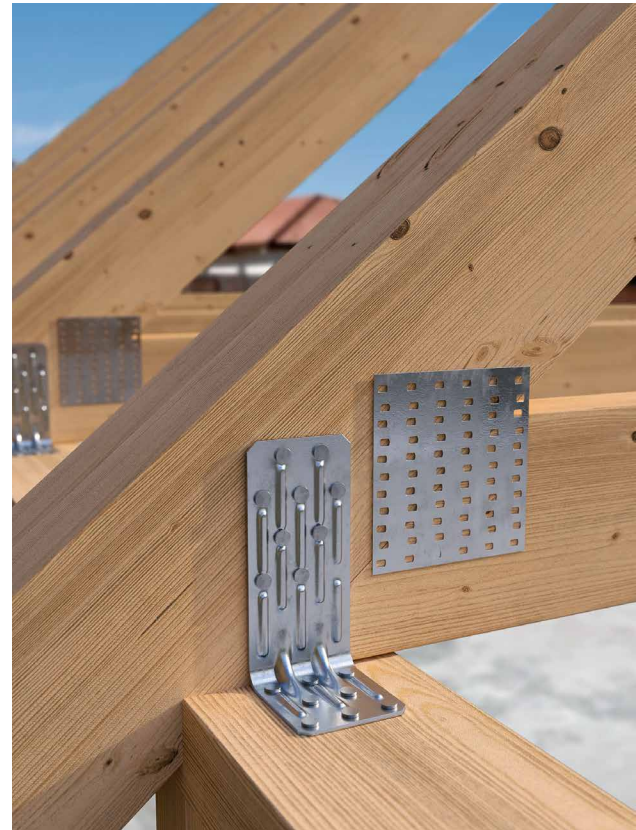
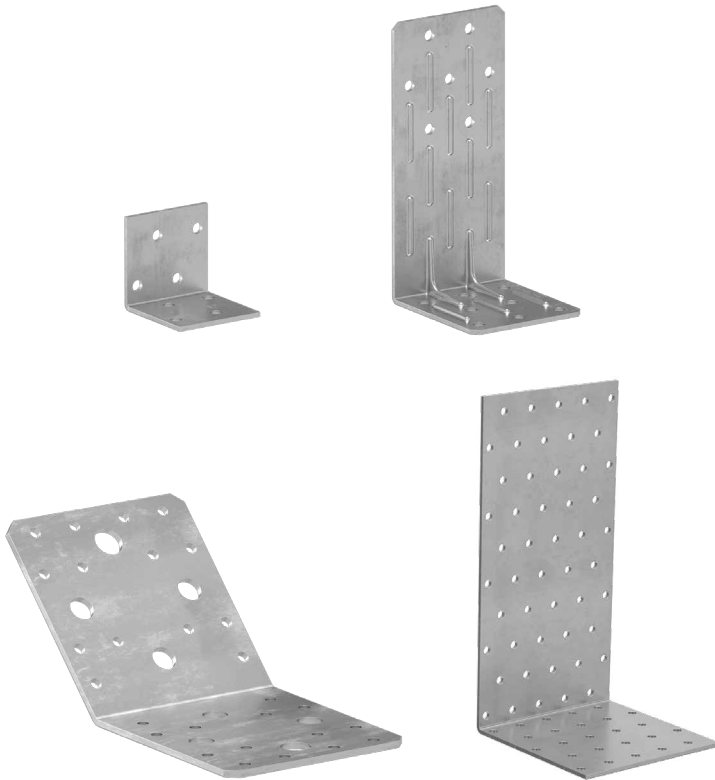

NUTZUNGSKLASSE

SC1	SC2	WBO, WVS, WHO	
SC1	SC2	SC3	WHO A2, LBV A2

MATERIAL

S250
Z275
WBO - WVS - WHO: Kohlenstoffstahl
S250GD + Z275

A2
AISI 304
WHO A2, LBV A2: Edelstahl A2 | AISI304

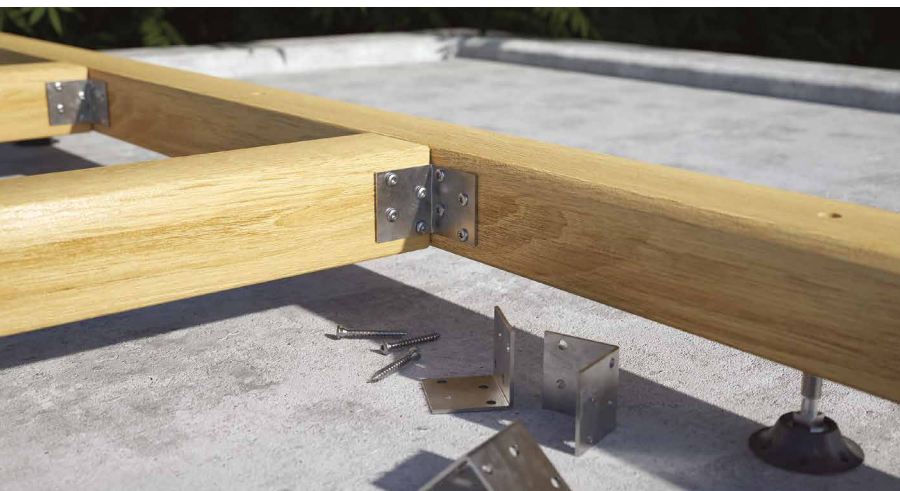

ANWENDUNGSBEREICHE

Statisch tragende und nichttragende Verbindungen für die Befestigung von Holzelementen aller Art.

Geeignet für kleine Konstruktionen, Möbel und kleine Tischlerarbeiten.

Anwendung:



- Massiv- und Brettschichtholz
- LVL
- andere Holzwerkstoffe

ARTIKELNUMMERN UND ABMESSUNGEN

WBO 50 - 60 - 90

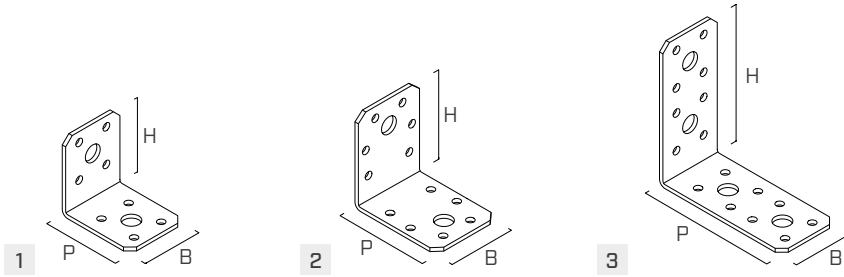
S250
Z275





ART.-NR.	B [mm]	P [mm]	H [mm]	s [mm]	n Ø5 [Stk.]	n Ø11 [Stk.]			Stk.
1 WBO5040	40	50	50	2,5	8	2	●	●	150
2 WBO6045	45	60	60	2,5	12	2	●	●	50
3 WBO9040	40	90	90	3,0	16	4	●	●	100

WBO 135°

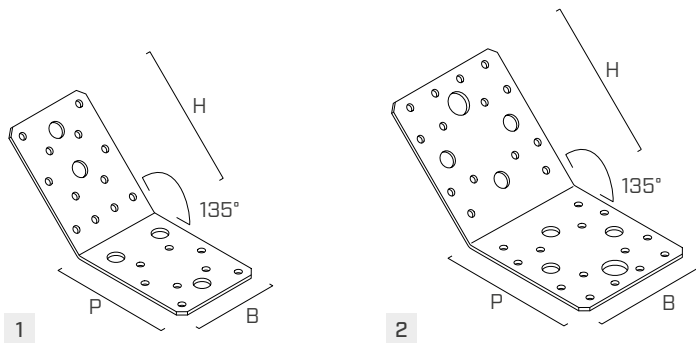
S250
Z275





ART.-NR.	B [mm]	P [mm]	H [mm]	s [mm]	n Ø5 [Stk.]	n Ø11 [Stk.]	n Ø13 [Stk.]			Stk.
1 WBO13509	65	90	90	2,5	20	5	-	●	●	100
2 WBO13510	90	100	100	3,0	28	6	2	●	●	40

WVS 80 - 120

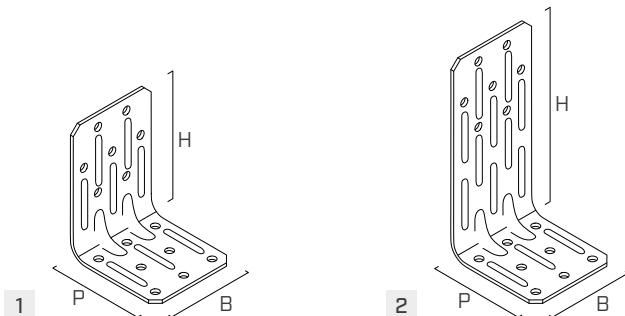
S250
Z275





ART.-NR.	B [mm]	P [mm]	H [mm]	s [mm]	n Ø5 [Stk.]			Stk.
1 WVS8060	55	60	80	2,0	15	●	-	100
2 WVS12060	55	60	120	2,0	15	●	-	100

ARTIKELNUMMERN UND ABMESSUNGEN

WVS 90

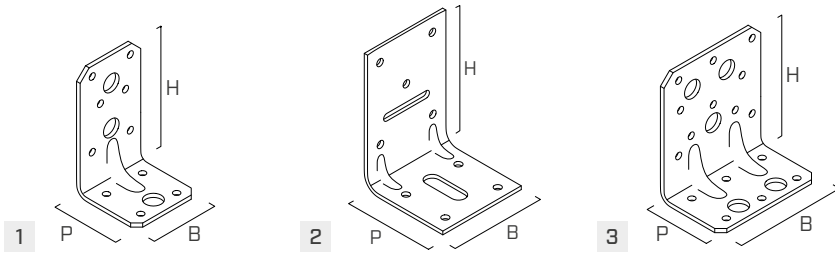
S250
2275





ART.-NR.	B	P	H	s	n Ø5	n Ø13	n Ø _v	n Ø _H			Stk.
	[mm]	[mm]	[mm]	[mm]	[Stk.]	[Stk.]	[Stk.]	[Stk.]			
1 WVS9050	50	50	90	3,0	10	3	-	-	●	●	100
2 WVS9060	60	60	90	2,5	9	-	1 - Ø5 x 30	1 - Ø10 x 30	●	-	100
3 WVS9080	80	50	90	3,0	16	5	-	-	●	●	100

WHO 40 - 60

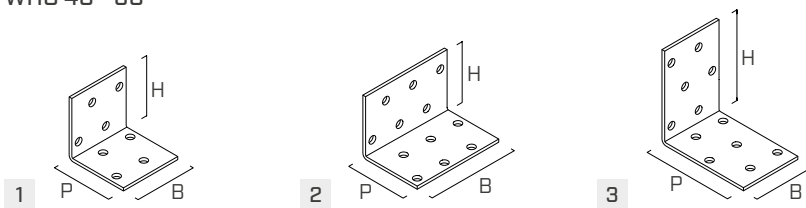
S250
2275





ART.-NR.	B	P	H	s	n Ø5	n _v Ø5	n _H Ø5			Stk.
	[mm]	[mm]	[mm]	[mm]	[Stk.]	[Stk.]	[Stk.]			
1 WHO4040	40	40	40	2,0	8	4	4	●	-	200
2 WHO4060	60	40	40	2,0	12	6	6	●	-	150
3 WHO6040	40	60	60	2,0	12	6	6	●	-	150

WHO 120 - 160 - 200

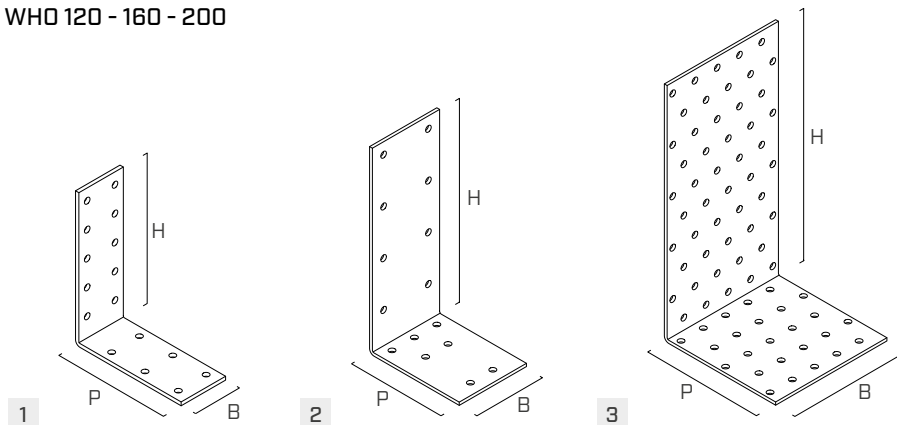
S250
2275



ART.-NR.	B	P	H	s	n Ø5	n _v Ø5	n _H Ø5			Stk.
	[mm]	[mm]	[mm]	[mm]	[Stk.]	[Stk.]	[Stk.]			
1 WHO12040	40	95	120	3,0	16	10	6	●	-	100
2 WHO16060	60	80	160	4,0	15	8	7	●	-	50
3 WHO200100	100	100	200	2,5	75	50	25	●	-	25

WHO A2 | AISI304 - LBVA A2 | AISI304

A2
AISI 304

ART.-NR.	B	P	H	s	n Ø4,5	Stk.
	[mm]	[mm]	[mm]	[mm]	[Stk.]	
1 WHOI1540	15	40	40	1,75	4	50
2 LBVI15100	15	100	-	1,75	4	50

